

V 3.0

# AM-2 REVISION 2 MANUAL



It is important that you read this manual before attempting the installation of your battery. Please take note of certain steps to ensure correct inverter compatibility.

Please visit <https://www.hubblelithium.co.za> for the latest version of this manual.



## **WARNING:**

Working with high voltage systems is dangerous. Do not attempt to modify your inverter and battery setup unless you are certain you understand the risk. Speak to a qualified electrician if you are unsure.

# INDEX

**AM2 WIRE DIAGRAM** \_\_\_\_\_ 1

## SECTION 1

**INSTALLATION** \_\_\_\_\_ 2

**MULTIPLE BATTERIES** \_\_\_\_\_ 3

**COMMUNICATION PORTS** \_\_\_\_\_ 4

## SECTION 2

**INVERTER SETUP** \_\_\_\_\_ 5

## SECTION 3

**LED INDICATORS** \_\_\_\_\_ 6

## SECTION 4

**BMS & MAINTENANCE** \_\_\_\_\_ 7

## SECTION 5

**COMPLETING SETUP** \_\_\_\_\_ 8

Watch the AM-2 Installation Tutorial on Youtube: <https://youtu.be/F5inYAPw2qg>

# AM-2

## WIRE DIAGRAM

1. Cover
2. Hanging Ear
3. Handle
4. Output Terminal
5. Cooling Case
6. Power Switch
7. Communication Interface
8. Reset Switch
9. LED Lights

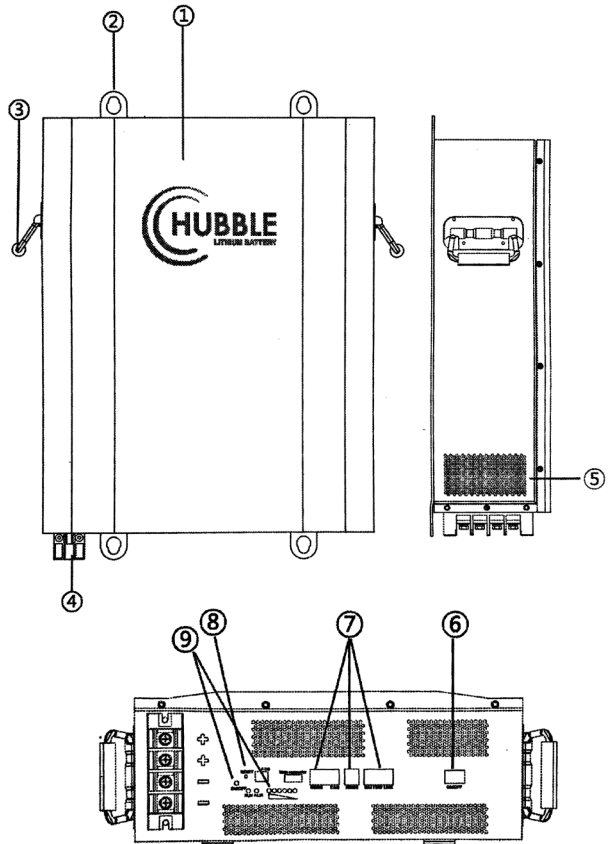

# SECTION 1

## INSTALLATION

### **⚠ WARNING**

*This product may only be installed by a qualified electrician. The unit is not designed to be installed upside down or sideways on a wall.*

The AM-2 is designed to be wall-mounted or installed flat inside a cabinet. When installing on a wall ensure you use Rawl bolts to secure the unit to the wall.

### **DC ISOLATOR**

The Hubble AM series of batteries has an integrated electronic circuit breaker built into the BMS. The integrated electronic CB is for protecting the battery and the internal cells against overload, over current, over volt etc. It is however required to install an external DC fuse or circuit breaker before using or operating the batteries. Please ensure you use the correct rating as per battery specification.

### **DIP SWITCH SETTINGS**

Configure each battery address to enable proper setup and communication. Each battery needs a unique serial address in order to communicate. If you are only using one battery in your setup, ensure you set the battery to Address 1.



Address	Dip Switch				Remark
	#1	#2	#3	#4	
1	ON	OFF	OFF	OFF	Master
2	OFF	ON	OFF	OFF	Battery 2
3	ON	ON	OFF	OFF	Battery 3
4	OFF	OFF	ON	OFF	Battery 4
5	ON	OFF	ON	OFF	Battery 5
6	OFF	ON	ON	OFF	Battery 6
7	ON	ON	ON	OFF	Battery 7
8	OFF	OFF	OFF	ON	Battery 8
9	ON	OFF	OFF	ON	Battery 9
10	OFF	ON	OFF	ON	Battery 10
11	ON	ON	OFF	ON	Battery 11
12	OFF	OFF	ON	ON	Battery 12
13	ON	OFF	ON	ON	Battery 13
14	OFF	ON	ON	ON	Battery 14
15	ON	ON	ON	ON	Battery 15

# MULTIPLE BATTERIES

To connect multiple batteries, ensure you use the supplied RJ45 to RJ45 (standard LAN cable) and plug the one end into the master "Battery Link", and the other end into battery #2. Continue this step until all the batteries have been linked up

Continue to wire up the DC block terminals of each battery to the inverter/charger. Once you have completed the address configuration, inverter-battery communication links and wired up the DC connections you can proceed to configure the inverter charge settings.

## NOTE: BATTERY LINK CABLE

If you do not have a battery link cable or the cable provided is an insufficient length, you can use a standard computer LAN cable to connect each battery. The pin layouts for the ports are the same as the universal LAN cable.

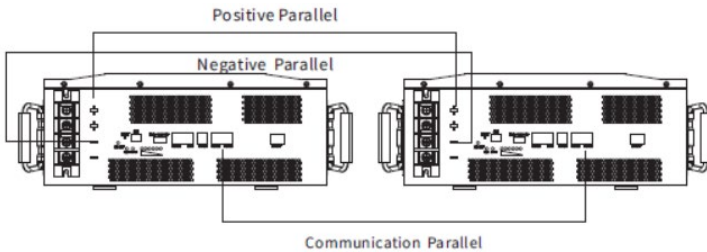

## ⚠ WARNING: PROTECTION MODE

If your batteries are unbalanced or the voltage of each pack is different by more than 2 Volts DC then your packs will try to inter balance by over 100Amps. This could cause the other batteries in the configuration to Over Current and go into protection mode. If this occurs, charge each pack full individually with the inverter/charger, then switch the other packs on once each has been charged to 100%.

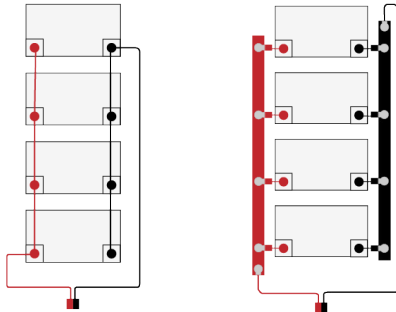

DIAGRAM 1

DIAGRAM 2

## CORRECT METHODS OF BATTERY LINKING

### Note Diagram 1:

Maximum of 4 batteries in parallel or maximum inverter current not exceeding 250Amps.

### Note Diagram 2:

The preferred method for battery paralleling is to connect each parallel battery to a busbar. Ensure all cables are the same length from each battery, and ensure the cable thickness are all the same to ensure even distribution of current and load.

# COMMUNICATION

## PORTS

### RS485 COMMUNICATION PORT

The RS485 interface is used only for performing firmware updates directly for the BMS. This port cannot be used for any inverter communications.

**PLEASE NOTE:**

This port is reserved for administrative and workshop technicians

### RS232 COMMUNICATION PORT

The RS232 interface is used to connect to either the Hubble Cloudlink device or for technical support to interface directly through a service laptop and access the BMS directly for programming and troubleshooting.



**WARNING: FIRE HAZARD & WARRANTY VOID  
DO NOT CONNECT THIRD PARTY DEVICE**

*It is strictly forbidden to access or interfere directly with the battery BMS through third party devices such as monitoring devices or logging devices that are not Hubble Lithium products. Third party monitoring and interfacing devices have the potential to change charge voltages and algorithms inadvertently - this can cause a catastrophic fire hazard. Therefore, interfacing to the BMS directly without authorization will void the warranty and Hubble Lithium will not be liable for any resulting damages.*

### OPTIONAL CLOUDLINK DEVICE

The Hubble Cloudlink is an optional add-on to the Hubble X and AM range of products. As long as the device is connected to Wi-Fi it will cloud, all battery and inverter data to our cloud-server, enabling users to remotely monitor their power system.



**Learn more about the Hubble Cloudlink here:**

<https://www.hubblelithium.co.za/hubble-cloudlink.html>

**Access the latest Cloudlink Setup Guide here:**

<https://www.hubblelithium.co.za/cloudlink-setup.html>

# SECTION 2

## INVERTER SETUP

### PRE-LAUNCH INVERTER SETUP

Set your Inverter/charger to the corresponding settings below before you start charging or using the lithium batteries.

INVERTER/CHARGER SETTINGS	
BULK / EQUALISATION CHARGE	53.6 V
FLOAT CHARGE	53.6 V
LOW DC CUTOFF	44 V

### IMPORTANT NOTICE:

SET THE VOLTAGES CORRECTLY AS OUT OF RANGE VOLTAGES CAN DAMAGE THE BATTERY.

AXPERT RECOMMENDED SETTINGS		
VOLTAGE POINT BACK TO UTILITY	47 V	Axpert Type
VOLTAGE POINT BACK TO BATTERY	53 V	Axpert Type

The recommended cutoff is 44V ~ 45V. However, the internal battery cutoff is as low as 40V. Setting the cutoff to 40V will drain the battery to 0%. For extended lifespan we recommend a cutoff of 44V ~ 45V.

### CAN BUS SETUP (OPTIONAL)

The AM series models has an integrated CAN bus port on each battery. The CAN bus can be used to connect to any inverter that is CAN bus ready.

To connect the CAN bus cable from the battery to the inverter, ensure you have the correct pin layouts. Firstly, ensure that you have the pin layout for the cable required for your inverter. If you do not have this information, we list select inverter pin layouts under the "Inverter Guides" tab on our website: <https://www.hubblelithium.co.za/>

The below is the pin configuration for the Hubble battery CAN cable:

PIN	DEFINITION
1	-
2	GROUND
3	-
4	CANH
5	CANL
6	-
7	-
8	-

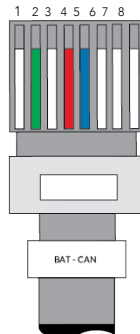

### PLEASE NOTE: INVERTER SETUP GUIDES







If you are setting up a non-axpert type inverter, for example Deye or Sunsynk - please navigate to the Inverter Setup Guides tab on our website and select the correct corresponding inverter guide:

<https://www.hubblelithium.co.za>

# SECTION 3

## LED INDICATORS

### LED OPERATION STATUS

STATUS	NORMAL / ALARM / PROTECTION	RUN	ALM	SOC INDICATION LEDS				REMARK
								
POWER OFF	Sleep	OFF	OFF	OFF	OFF	OFF	OFF	All off
STANDBY	Normal	Fash 1	OFF	Indication by SOC				Standby state
	Alarm	Flash 1	Flash 3					Cell low voltage
CHARGE	Normal	ON	OFF	Indication by SOC (The top SOC LED Flash 2)				ALM LED off when Cell Over-charge Voltage Alarm
	Alarm	ON	Flash 3					
	Over Charge Protection	ON	OFF	ON	ON	ON	ON	If no mains supply, LED as standby
	Temperature/ Over-current Fault Protection	OFF	ON	OFF	OFF	OFF	OFF	
DISCHARGE	Normal	Flash 3	OFF	Indication by SOC				
	Alarm	Flash 3	Flash 3					
	Under Discharge Protection	OFF	OFF	OFF	OFF	OFF	OFF	
	Temperature Alarm or Over-Current Alarm or Short Circuit Protection	OFF	ON	OFF	OFF	OFF	OFF	
	Fault	OFF	ON	OFF	OFF	OFF	OFF	

### LED FLASH STATUS

When battery is turned on you can reset the BMS operation mode to default to clear a temporary alarm status. Push the switch for 6 seconds, the BMS will reset. LEDs will flash one at the same.

FLASH	ON	OFF
FLASH 1	0.35 S	3.75 S
FLASH 2	0.5 S	0.5 S
FLASH 3	0.5 S	1.5 S



# SECTION 4

## BMS & MAINTENANCE

### BMS LOW POWER MODE

The Hubble BMS will enter low power mode if the following conditions happen:

1. When over-discharge protection has occurred. (30S later).
2. When all cell-voltage is less than the Sleep voltage parameter setting to prevent complete cell/ battery drain.
3. Standby time is more than 24 hours (without charge and discharge current, without balance, without protection and fault).

### BMS EMC SAFETY

#### ESD:

Complies with Level 4 of GB/T 17626.2-2006 (EN55024): 8KV at contact and 15KV at air. Normal operation after test.

#### ELECTROMAGNETIC CONDUCTION:

Complies with Lever A of YD/T 983-1998 (EN55022)

#### ELECTROMAGNETIC RADIATION:

Complies with Lever A of YD/T 983-1998 (EN55022)

#### INRUSH:

Complies with GB/T 17626.5-2008 (EN6100-4-2).

### DATA STORAGE

The Hubble BMS has a built-in alarm and event data storage memory. Alarms and events are recorded as, occurrence time, fault categories, over/under cell voltage, pack voltage, charge/discharge capacity, charge/discharge current, temperature, etc. This can be downloaded by a service technician to help troubleshoot any issues or problems of the battery.

### MAINTENANCE

The Hubble BMS will protect the battery and lifespan of your battery as best possible. However, it must be noted that proper operation of the battery is recommended, and maintenance functions should be taken to ensure the maximum life of your batteries.

Cell balancing is a very important function of the lifespan of your battery. It is important to ensure the cell balancing functions are properly performed. The Hubble BMS cell balancer will only activate upon 100% state of charge when the batteries near full charge. Thus, it is critical that a full charge to the batteries are provided at least once every 5 (five) days, but preferably daily upon a charge cycle. Enough charge time should be provided to balance the cells until the BMS completely stops taking charge from the inverter. Cell cycle life cannot be guaranteed if balancing is not performed on a regular basis. This is especially important in complete off grid systems where a stable power supply is not available.

# SECTION 5

## COMPLETING SETUP

# CONGRATULATIONS!

Once all the above steps have been completed you can proceed to follow the start-up instructions given by your inverter manufacturer.

If you have any difficulties with setting up your system, please contact our Technical Support Department via [support@hubblelithium.co.za](mailto:support@hubblelithium.co.za). Be sure to include the following information in your initial email so that we can provide you with timely assistance:

1. Inverter make & model
2. Model & number of connected batteries
3. Are your batteries in Series or Parallel?
4. A brief description of your system and any issues you may be having
5. If possible; images of your power system
6. Contact Details, if we should need to contact you



**SUBSCRIBE TO OUR  
YOUTUBE CHANNEL  
TO VIEW OUR VIDEO  
TUTORIALS:**

[https://www.youtube.com/channel/  
UCaY\\_AJhdFtUqoWlWOWscv\\_Q](https://www.youtube.com/channel/UCaY_AJhdFtUqoWlWOWscv_Q)